

TYPE 4 JIC CONTINUOUS HINGE ENCLOSURES



Industry Standards
UL 508A, Type 4, 12, 13
NEMA Type 4, 12, 13



UL File E235575

TYPE 4 ENCLOSURES

Application:

Designed to enclose electrical, electronic controls, instruments and components. Provides protection in areas that are hosed down or very wet.

Construction:

- Steel fabricated doors and enclosures.
- Smooth, continuously welded seams without knockouts, cutouts, or holes.
- Welded brackets provided for enclosure mounting.
- Doors secured with stainless steel continuous hinge and JIC style clamps.
- Doors sealed with closed cell, oil resistant gasket.
- Internal weld studs are provided for mounting optional inner panels.

Finish:

- ANSI 61 gray powder coating inside and out over phosphatized surfaces. Optional panels are powder coated white.

Accessories:

- Back Panels (see reference chart, pg. 6-1).

Options:

- Custom sizes and colors available. Please call for details.

Enclosure Catalog Number	Enclosure Size H x W x D	Body/Door Steel Gauge	X	Back Panel Catalog Number			Back Panel Size A x B	Back Panel Gauge
				PP-0806	P2-0806	PS-0806		
N4JCH-080604	8.00" x 6.00" x 4.12"	16/16	3.62"	PP-0806	P2-0806	PS-0806	6.750" x 4.875"	14
N4JCH-100804	10.00" x 8.00" x 4.12"	16/16	3.62"	PP-1008	P2-1008	PS-1008	8.750" x 6.875"	14
N4JCH-121006	12.00" x 10.00" x 6.12"	16/16	5.62"	PP-1210	P2-1210	PS-1210	10.750" x 8.875"	14
N4JCH-141206	14.00" x 12.00" x 6.12"	16/16	5.62"	PP-1412	P2-1412	PS-1412	12.750" x 10.875"	14
N4JCH-141208	14.00" x 12.00" x 8.12"	16/16	7.62"	PP-1412	P2-1412	PS-1412	12.750" x 10.875"	14
N4JCH-161406	16.00" x 14.00" x 6.12"	14/14	5.62"	PP-1614	P2-1614	PS-1614	14.750" x 12.875"	14
N4JCH-161408	16.00" x 14.00" x 8.12"	14/14	7.62"	PP-1614	P2-1614	PS-1614	14.750" x 12.875"	14



211 INDUSTRIAL COURT
WABASHA, MN 55981

Phone: (651) 565-3395
Fax: (651) 565-2787
E-mail: info@thomasindustriesinc.com
www.thomasindustriesinc.com

*DATA SUBJECT TO CHANGE WITHOUT NOTICE

TYPE 4 JIC CONTINUOUS HINGE ENCLOSURES

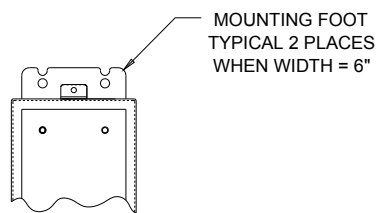
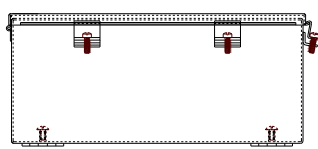
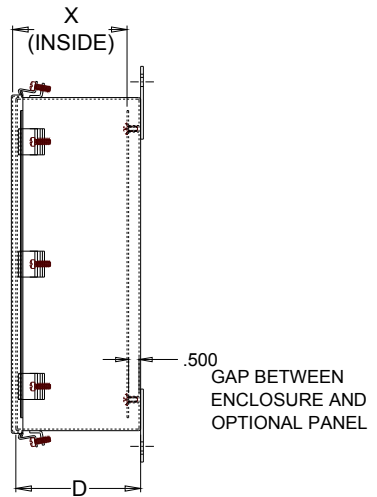
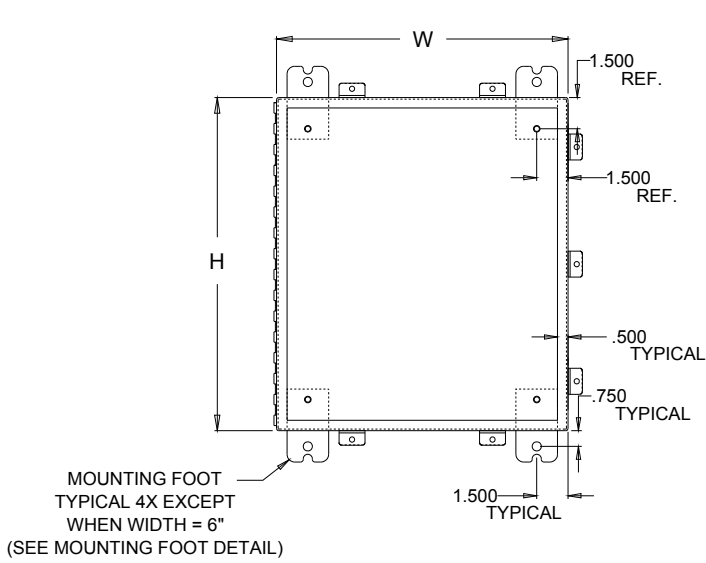

MOUNTING FOOT DETAIL

N4JCH-080604

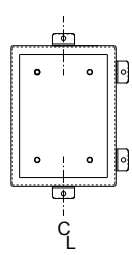

N4JCH-100804

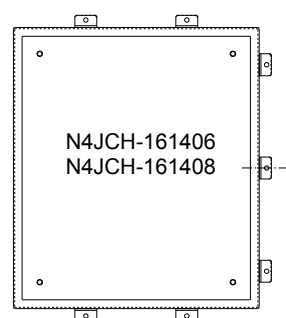
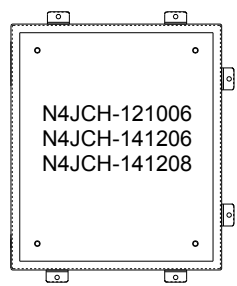
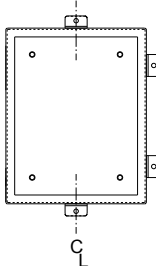

211 INDUSTRIAL COURT
WABASHA, MN 55981

Phone: (651) 565-3395
Fax: (651) 565-2787
E-mail: info@thomasindustriesinc.com
www.thomasindustriesinc.com

*DATA SUBJECT TO CHANGE WITHOUT NOTICE